

SELF-ALIGNED MANIFOLDS



[FLEXUS data sheet](#)

Self-aligned manifolds

Contents

DESCRIPTION	3
ADVANTAGES	3
FIELDS OF APPLICATION	4
6200.E7: COMPONENTS AND MATERIALS	5
6200.E7-6300.E7: SCREW COMPONENTS AND MATERIALS	6
6200.R6: COMPONENTS AND MATERIALS	7
6300.E7: COMPONENTS AND MATERIALS	8
6200.E7: CONNECTION GUIDE	9
6200.R6: CONNECTION GUIDE	11
6300.E7: CONNECTION GUIDE	13
CERTIFICATIONS	15
REGULATIONS	15
ASSEMBLY	16
AC00.70 MANIFOLDS CABINET	16

FLEXUS

Self-aligned manifolds

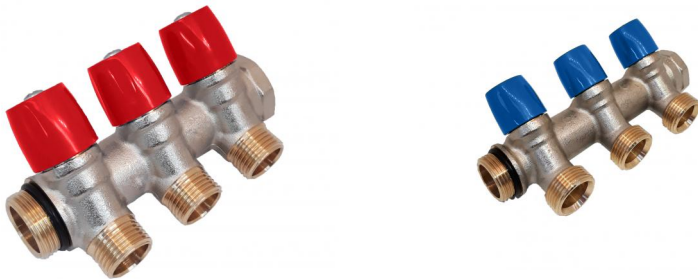





DESCRIPTION

FLEXUS manifolds are suitable for heating and sanitary water distribution. Self-aligning grants the aligning of the coupled manifolds without using any additional means, such as teflon tape or hemp. They are available with screws (6200 and 6300) or with mini valves (6200.R6). Flexus manifolds are suitable for sanitary, heating and cooling installations. Their configuration allows the realization of hot and/or cold circuits in parallel.

ADVANTAGES

- SELF ALIGNING granting the correct and quick aligning of the coupled manifolds
- CONSTANT CENTER DISTANCE
- PERFECTLY TIGHT: thanks to the O-Ring the coupling is tight without using any additional means, such as Teflon tape or hemp, for a faster installation
- ENCUMBRANCES REDUCTION as there is no need to use hemp or other sealants
- Suitable for drinking water
- Product traceability guaranteed by the date stamped on the body of the manifold (only for 6200.E7)
- Reinforced collar
- Raw materials complying with UBA LIST
- Suitable for plastic, metal and metal-plastic pipes
- Available with screws and mini valves





FIELDS OF APPLICATION

APPLICATIONS	T. min.	T. max	T.of the system	Max. pressure
 drinking water	-20°C	+120°C	-20°C +95°C	10 bar
 hot sanitary water	-20°C	+120°C	-20°C +95°C	10 bar
 cooling	-20°C	+120°C	-20°C +95°C	10 bar
 radiators	-20°C	+120°C	-20°C +95°C	10 bar

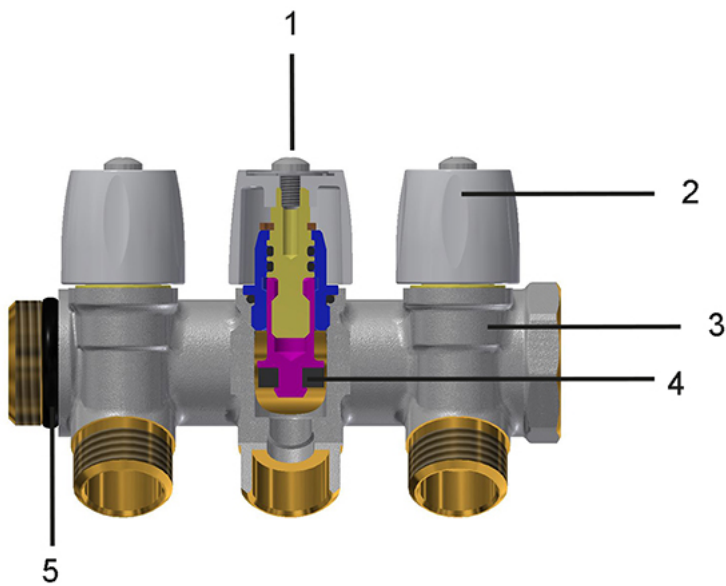
-20°C: only with antifreeze liquid (glycol) in % max of 30%







6200.E7: COMPONENTS AND MATERIALS

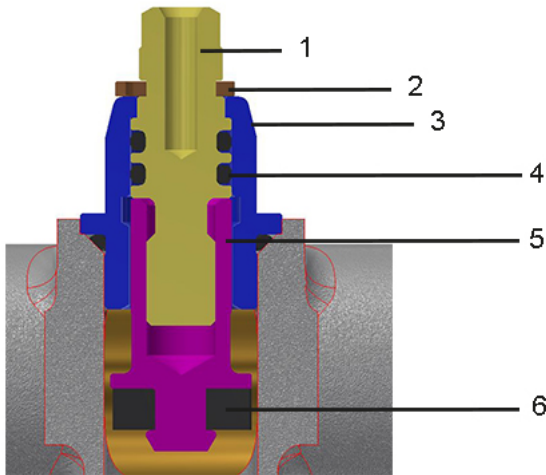

LEGEND		COMPONENTS	MATERIALS
	1	Screw	Steel CB4F
	2	Handle	ABS
	3	Body	Brass CW617N - UNI EN 12165
	5	Self-seal O-Ring	Elastomer for drinking water
	4	Flat seal	Elastomer for drinking water

6200.E7-6300.E7: SCREW COMPONENTS AND MATERIALS



LEGEND	COMPONENTS	MATERIALS
	1 Stem	Brass CW617N - UNI EN 12165
	2 Stop fork	Phosphor bronze
	3 Body	Brass CW617N - UNI EN 12165
	4 O-Ring	Elastomer for drinking water
	5 Valve	Brass CW617N - UNI EN 12165
	6 Flat seal	Elastomer for drinking water



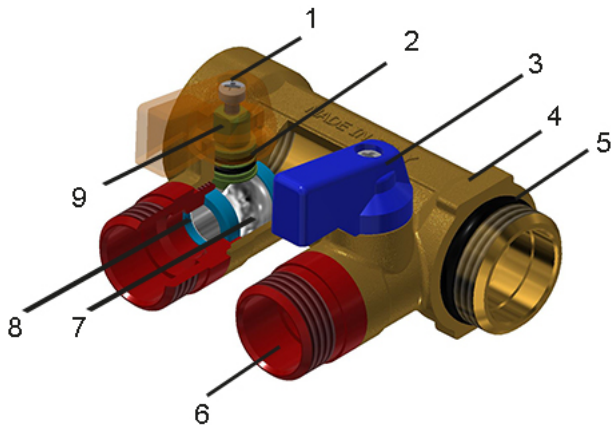



6200.R6: COMPONENTS AND MATERIALS

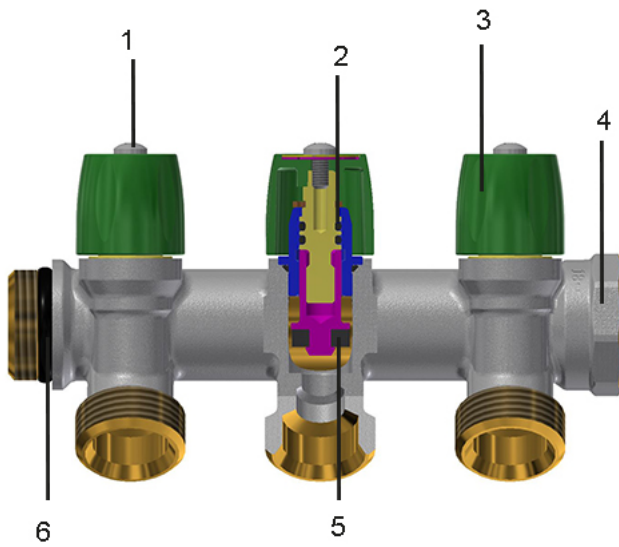

LEGEND		COMPONENTS	MATERIALS
	1	Screw	Fe galvanized
	2	O-Ring	Elastomer for drinking water
	3	Lever	ABS
	4	Body	Brass CW617N - UNI EN 12165
	5	Self-seal O-Ring	Elastomer for drinking water
	6	Straight union	Brass CW617N - UNI EN 12165
	7	Ball	CW617N chromed
	8	Ball seal	Elastomer for drinking water
	9	Stem	Brass CW617N - UNI EN 12165

6300.E7: COMPONENTS AND MATERIALS



LEGEND		COMPONENTS	MATERIALS
	1	Screw	Steel CB4F
	2	O-Ring	Elastomer for drinking water
	3	Handle	ABS
	4	Body	Brass CW617N - UNI EN 12165
	5	Flat seal	Elastomer for drinking water
	6	Self-seal O-Ring	Elastomer for drinking water

6200.E7: CONNECTION GUIDE

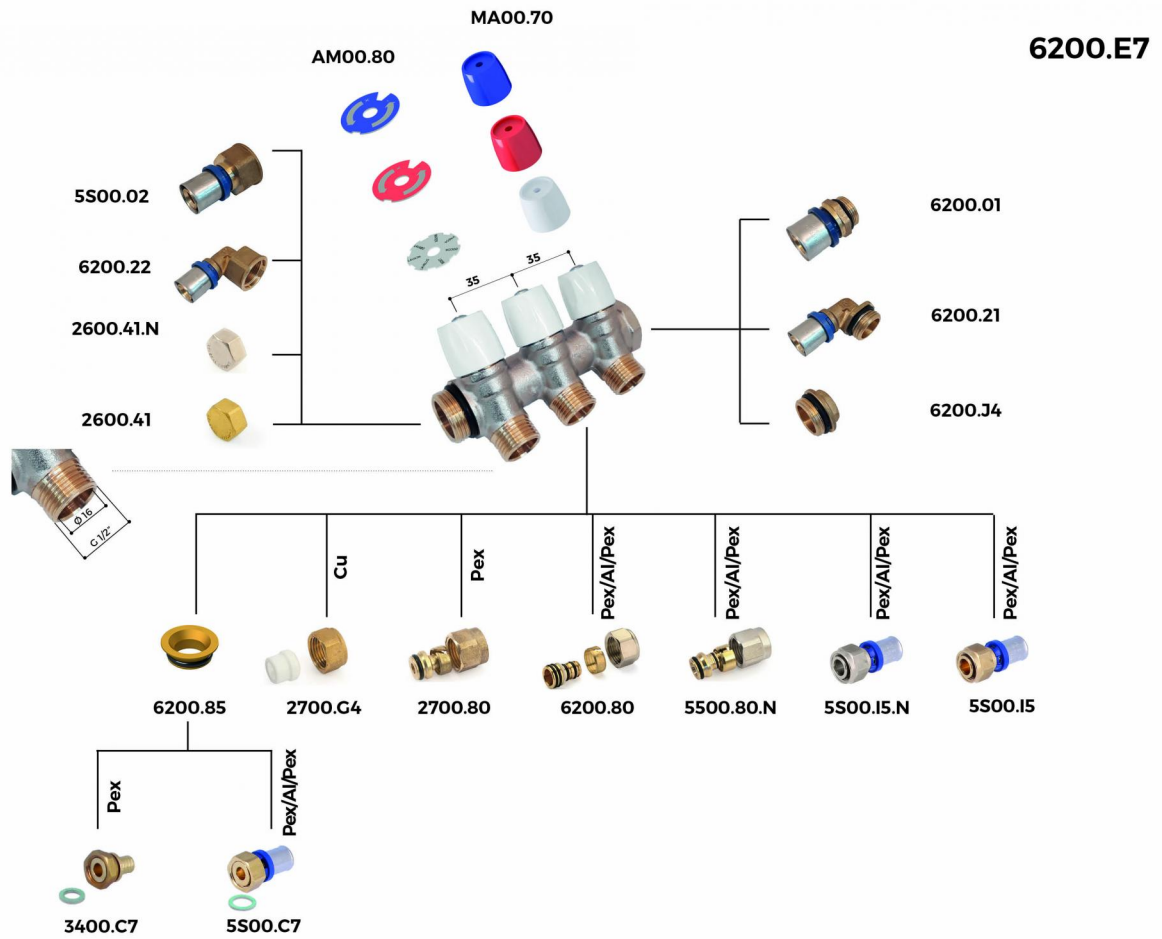

INSERTS AND FITTINGS

CODE	DESCRIPTION	PIPE
6200.85	Flat seal adapter	3400.C7: Pe-X pipe - 5500.C7: multilayer pipe
2700.G4	Nut and monocone P.T.F.E	copper pipe
2700.80	Nut, olive and insert	Pe-X pipe
6200.80	Nickel-plated nut, olive and insert	multilayer pipe
5500.80.N	Nickel-plated nut, olive and insert	multilayer pipe
5500.I5	Straight fitting with loose nut and eurocone	multilayer pipe
5500.I5.N	Nickel plated straight fitting with loose and eurocone	multilayer pipe
6200.01	Male straight fitting with O-Ring	
6200.02	Female straight fitting with O-Ring	
6200.21	Self-seal male elbow with O-Ring	
5500.02	Female straight fitting	
6200.22	Self-seal female elbow with O-Ring	

INSERTS AND FITTINGS

2600.41/41.N	Female cap / Nickel plated female cap	
6200.J4	Male cap with O-Ring	

6200.R6: CONNECTION GUIDE

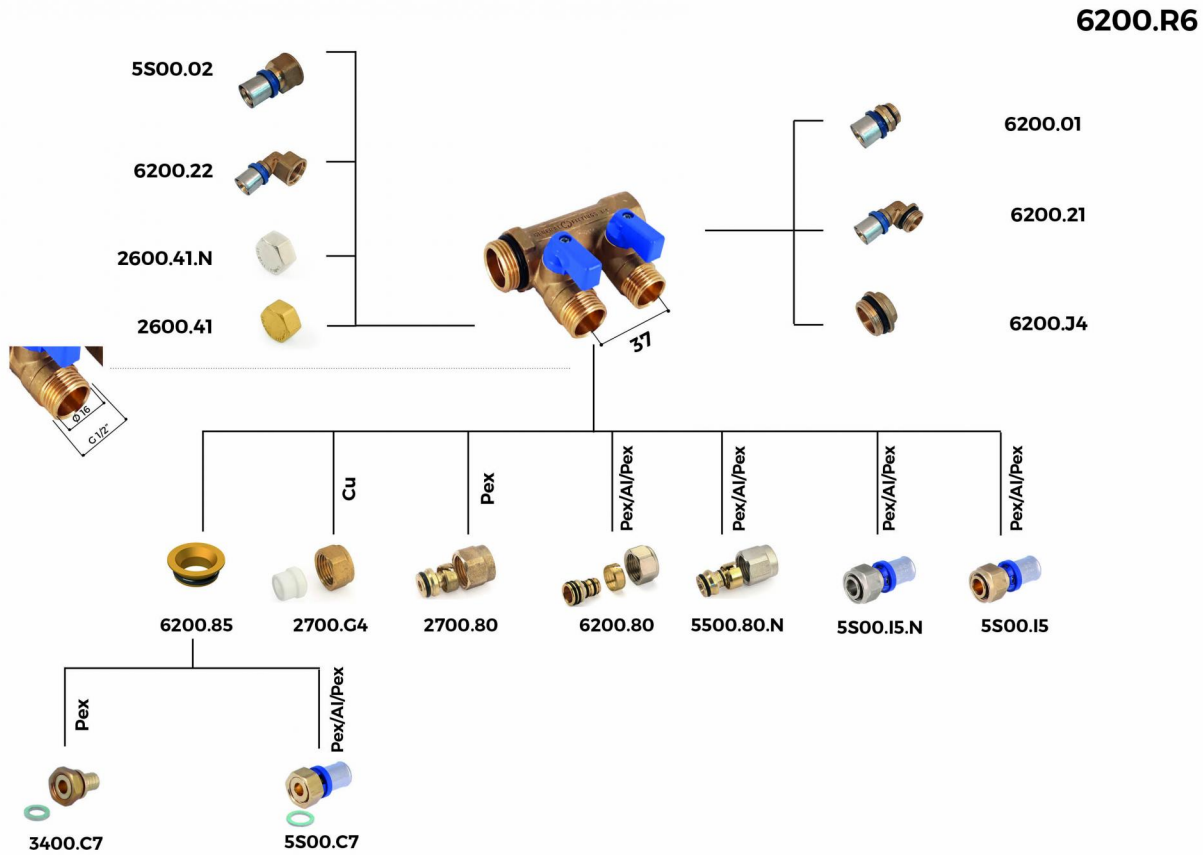

INSERTS AND FITTINGS

CODE	DESCRIPTION	PIPE
6200.85	Flat seal adapter	3400.C7: Pe-X pipe - 5500.C7: multilayer pipe
2700.G4	Nut and monocone P.T.F.E	copper pipe
2700.80	Nut, olive and insert	Pe-X pipe
6200.80	Nickel-plated nut, olive and insert	multilayer pipe
5500.80.N	Nickel-plated nut, olive and insert	multilayer pipe
5500.I5	Straight fitting with loose nut and eurocone	multilayer pipe
5500.I5.N	Nickel plated straight fitting with loose nut and eurocone	multilayer pipe
6200.01	Male straight fitting with O-Ring	
6200.02	Female straight fitting with O-Ring	
6200.21	Self-seal male elbow with O-Ring	
5500.02	Female straight fitting	
6200.22	Self-seal female elbow with O-Ring	

INSERTS AND FITTINGS

2600.41/41.N	Female cap / Nickel plated female cap	
6200.J4	Male cap with O-Ring	

6300.E7: CONNECTION GUIDE

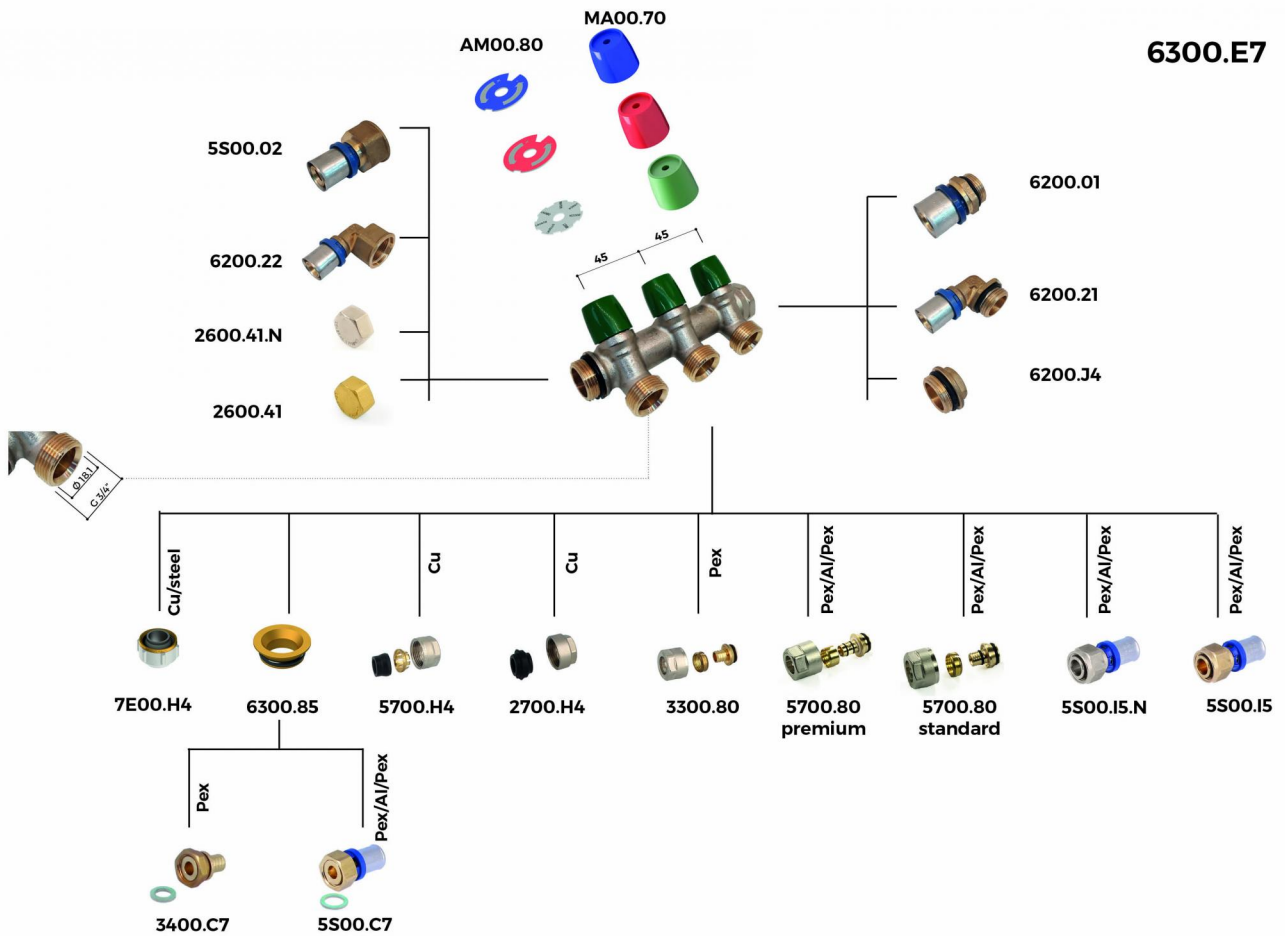

















INSERTS AND FITTINGS

CODE	DESCRIPTION	PIPE
7E00.H4	Eurocone kit	copper and steel pipe
6300.85	Flat seal adapter	3400.C7: Pe-X pipe - 5500.C7: multilayer pipe
5700.H4	Nickel plated nut with assembled ring and gasket	copper pipe
2700.H4	Nickel plated nut with assembled ring and gasket	copper pipe
3300.80	Nickel plated nut, olive and insert eurocone	Pe-X pipe
5700.80 premium 5700.80 standard	Nickel plated nut, olive and insert eurocone	multilayer pipe
5500.I5	Straight fitting with loose and eurocone	multilayer pipe
5500.I5.N	Nickel plated straight fitting with loose and eurocone	multilayer pipe
6200.01	Male straight fitting with O-Ring	
6200.02	Female straight fitting with O-Ring	

INSERTS AND FITTINGS

6200.21	Self-seal male elbow with O-Ring	
5S00.02	Female straight fitting	
6200.22	Self-seal female elbow with O-Ring	
2600.41/41.N	Female cap / Nickel plated female cap	
6200.J4	Male cap with O-Ring	

CERTIFICATIONS

COUNTRY	CERTIFICATION	COUNTRY	CERTIFICATION	COUNTRY	CERTIFICATION
					
					
					

REGULATIONS

- UNI EN ISO 228-1:2003

Threads complies with UNI EN ISO 228-1:2003 law: "Piping thread for coupling not with tightness on the thread".

- UNI EN 13828 (only for 6200.R6)

"Ball valves of copper alloys and stainless steel hand operated, for the supply of drinking water in buildings".

- D.M. 174 (06/04/2004)

Raw materials used are of high quality and comply with the Ministerial Decree N°174 dated 06/04/2004 concerning the materials and the items used in fixed installations for water collection, treatment and supply.

- EN ISO 1254 part 2,3,4

Copper and copper alloys - Plumbing fittings

- Comply with 4MS, UBA List (BC group), DIN 50930/6 Dir. 2011/65/UE, 6C attachment III (RhOSII)

ASSEMBLY

FLEXUS manifolds can be assembled in AC00.70 cabinet which includes fixing kit.



AC00.70 MANIFOLDS CABINET

CODE	SIZE
AC0070H203295H	260x320x95
AC0070H204095H	260x400x95
AC0070H205095H	260x500x95



General Fittings Spa
Via Golgi, 73/75
25064 Gussago (BS) ITALY
Tel. +39 030 3739017
P.IVA 03448140172 - C.F. 01613110178
www.generalfittings.it